

















# SGDL-TC60MB SMART LOCK

With Card and Password Access



-  RFID Card
-  Password
-  Automatic Lock / Relock
-  Anti Hacking Emergency Alarm System
-  Adjustable Volume Level
-  External Emergency Battery Terminal (9V)
-  High Voltage Protection Circuit
-  Scramble Code
-  Intergrated With Fire Sensor
-  Easy To Use Even At Night
-  Self Diagnostic Function
-  Double Lock
-  Strong & Durable Body Components
-  Multi-Touch Feature
-  2 Years Warranty
-  Made In Korea

## Accessories



RFID STICKER



RFID CARD



RFID KEYTAG

## SGDL-TC60MB Smart Lock with Card and Password Access

### Measurement

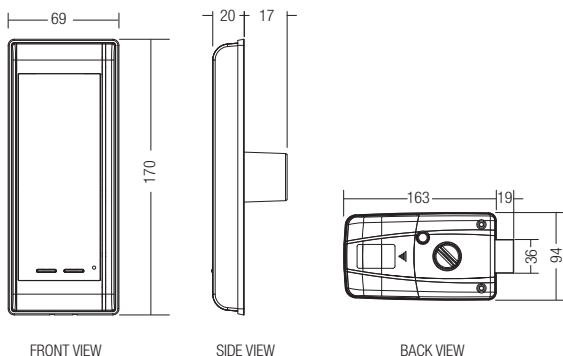

Specifications		
<b>Door Thickness</b>		40-50mm
<b>Finishing of Product</b>		Matt Black
<b>Power Supply</b>	Voltage DC 6V	LR6 1.5V AA Size alkaline Battery 4pcs
	Emergency battery DC 9V	Alkaline Battery (Sold Separately)
<b>Pin Number</b>		3-19 digit
<b>Authentication</b>	No. of pin registration	4
	No. of RFID card registration	30
<b>Heat Sensor</b>	Temperature sensor level	60° ± 10°
<b>Material</b>	Front body	Al, Zn, ABS
	In body	Al, Zn, ABS
<b>Included Accessories</b>	RFID card	2pcs
	RFID sticker	2pcs
	RFID key tag	2pcs
	1.5V AA Size alkaline battery	4pcs

\*All the measurements are in millimeter (mm)