















SGDL-MG350MB SMART LOCK FOR METAL GATE / IRON GRILLE

With Card, Password and Remote Control Access



-  RFID Card
-  Password
-  Automatic Lock / Relock
-  Scramble Code
-  Intergrated With Fire Sensor
-  Anti Hacking Emergency Alarm System
-  Adjustable Volume Level
-  High Voltage Protection Circuit
-  External Emergency Battery Terminal (9V)
-  Easy To Use Even At Night
-  Strong & Durable Body Components
-  Emergency key
-  Remote Control
-  2 Years Warranty
-  Made In Korea



Accessories



REMOTE CONTROL



RFID STICKER



RFID CARD



RFID KEYTAG



EMERGENCY KEY

SGDL-MG350MB

Smart Lock For Metal Gate / Iron Grille with Card, Password and Remote Control Access

Measurement

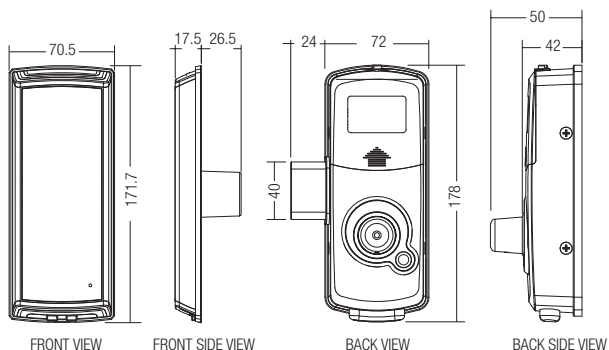

Specifications

Door Thickness		25~50mm
Finishing of Product		Matt Black
Power Supply	Voltage DC 6V	LR6 1.5V AA Size alkaline Battery 4pcs
	Emergency battery DC 9V	Alkaline Battery (Sold Separately)
Pin Number		3-19 digit
Authentication	No. of pin registration	1
	No. of RFID card registration	50
	No. of remote control registration	15
Remote Range - Maximum		50 Meter (depending on situation)
Heat Sensor	Temperature sensor level	60° ± 10°
Material	Front body	Al, Zn, ABS
	In body	Al, Zn, ABS
Included Accessories	RFID card	2pcs
	RFID sticker	2pcs
	RFID key tag	2pcs
	Remote control	2pcs
	1.5V AA Size alkaline battery	4pcs
	Emergency Key	3pcs

*All the measurements are in millimeter (mm)